

Getting Started with the MapleSim Control Design Toolbox

**Copyright © Maplesoft, a division of Waterloo Maple Inc.
2020**

Getting Started with the MapleSim Control Design Toolbox

Copyright

Maplesoft, Maple, and MapleSim are all trademarks of Waterloo Maple Inc.

© Maplesoft, a division of Waterloo Maple Inc. 2009-2020. All rights reserved.

No part of this book may be reproduced, stored in a retrieval system, or transcribed, in any form or by any means — electronic, mechanical, photocopying, recording, or otherwise. Information in this document is subject to change without notice and does not represent a commitment on the part of the vendor. The software described in this document is furnished under a license agreement and may be used or copied only in accordance with the agreement. It is against the law to copy the software on any medium except as specifically allowed in the agreement.

Macintosh is a registered trademark of Apple, Inc.

Modelica is a registered trademark of the Modelica Association.

All other trademarks are the property of their respective owners.

This document was produced using Maple and DocBook.

Contents

- Introduction iv
- 1 Getting Started 1
 - 1.1 Getting Help 1
 - 1.2 Using the MapleSim Control Design Apps 1
 - Viewing MapleSim Control Design Examples 1
 - 1.3 Example: DC Motor 1
 - Generating a Linearized Model 1
 - Creating a Custom Controller 2
- Index 4

Introduction

The MapleSim™ Control Design Toolbox provides the necessary control design tools to extend the plant modeling capabilities of MapleSim. Using a symbolic approach, you can design, analyze, and test control systems.

You can also use the technical documentation tools available with MapleSim to document your design decisions.

Features of this toolbox include:

- Model linearization
- Standard PID tuning techniques: Ziegler-Nichols time response, Ziegler-Nichols frequency response and Cohen-Coon
- Advanced PID tuning techniques: Dominant pole placement, pole placement in a specified region, and gain and phase margin
- State Feedback Control: Single input pole placement (Ackermann), multiple input pole placement, and LQR
- State Estimation: Single output pole placement (Ackermann), multiple output pole placement, and Kalman filter
- Access to commands in the **ControlDesign** and **DynamicSystems** packages in Maple™

Scope of Model Support

MapleSim Control Design Toolbox is a very comprehensive modeling tool where it is possible to design linear controllers for models created in MapleSim. The Control Design Toolbox linearizes systems of any complexity, including systems of DAEs of any index.

Systems that contain any type of discontinuity, including discrete transforms, switches, logic gates, relational and Boolean operations are not supported by the current release of this product.

1 Getting Started

1.1 Getting Help

In Maple, enter ?ControlDesign at a prompt in a worksheet.

1.2 Using the MapleSim Control Design Apps

The MapleSim Control Design Toolbox provides apps for linearizing MapleSim models and creating PID controllers. These Maple-based apps allow you to generate a linearized representation of your model subsystems, as well as custom components of your system controllers.

Viewing MapleSim Control Design Examples

Toolbox examples are available in MapleSim.

To view an example:

- From the **Help** menu, select **Examples > Control Design Examples**, and then select the model that you want to view.

Some models include additional documents, such as apps and templates that show model equations or define custom components. To open any of these documents:

1. Under the **Attached Files** tab () , expand **Documents**.
2. Right-click (**Control**-click for Mac®) on an attachment and select **View**. The attachment opens in Maple (for Maple worksheets) or in the appropriate program.

1.3 Example: DC Motor

In this example, you will generate a linearized state-space model of the models you created in MapleSim. You will then use this linearized model to create and tune a PID controller.

Generating a Linearized Model

To generate a linearized model:

1. From the **Help** menu, select **Examples > Control Design Examples**, and then select the **DC Motor - Getting Started** model.
2. Click **Add Apps or Templates** () , and from the **Apps** palette double-click on the **Linearization** entry under **Component Creation**. The **Analysis** window opens with the **Linearization** app opened in the **Apps** tab.
3. Using the drop-down list above the model, select the **DC Motor1** subsystem.

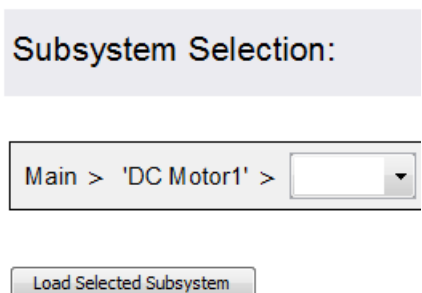

4. Click **Load Selected Subsystem**. In the Configuration section, the fields for the **Inputs**, **Outputs**, and **Parameters** tables are populated with information specific to the subsystem.
5. In the **Configuration** section, select **Linearization Options**.



You can now have the app automatically calculate an equilibrium point to be used as a linearization point or you can choose to have the model linearized about the initial point.

If you specify manual values in the Initial Conditions of a component, these will be used in the Initial Configuration of the system. Alternatively, to calculate the equilibrium point automatically, select **Equilibrium Point**. Also, to enable Baumgarte stabilization during linearization of the constraint equations, select **use Baumgarte**.

6. For this example, select **Equilibrium Point**.
7. In the **Linearize** section, click **Linearize** to generate the linearized model. In the **Analysis** section, you can select and view the matrices of your linearized model (select **Basic**). Select **Mappings** to view the state, input, and output mappings.
8. Scroll to the bottom of the app and under **Create Model** in the **Component Name** field, you can enter a custom name for the linearized model, for example, **MyMotor** for this example. In the description field, you can add more information about your model.
9. Click **Create** to create the linearized state-space model. A custom component with the specified component name (for example, **MyMotor**) now appears in the **Components** palette of the **Local Components** tab () of the DC Motor model in MapleSim.

Creating a Custom Controller

To create a custom controller:

1. If you are not in the top level of your model, click **Return to Main** () in the **Navigation Toolbar**.
2. Under the **Local Components** tab () , the **MyMotor** custom component is found in the **Components** palette. Place the **MyMotor** custom component in the **Model Workspace**.
3. Click **Add Apps or Templates** () , and then double-click the **PID Tuning** entry under **Control Design** in the **Apps** palette. The **Analysis** window opens with the **PID Tuning** app opened in the **Apps** tab.
4. In the **Linearized Model** section of the app, select the linearized model **MyMotor** from the drop-down list.
5. In the **Controller Design** section, you can select the tuning method and controller type you want to create. For this example, design a **PID** controller using the modified Ziegler-Nichols (MZN) Time Domain tuning method:

From the **Method** drop-down menu, select **Ziegler-Nichols Time Domain (MZN)**. From the **Controller** drop-down menu, select **PID**. If additional information is required for your control design method, the fields below these menus will be populated and you can enter the required information.

6. Click **Design Controller**.
7. Next, in the **Export to MapleSim** subsection, enter **MyPID**, and then click **Export to MapleSim**. A custom component generates and exports to MapleSim.

Notes:

- You can view the Modelica® code generated for the custom component in the **Modelica Code Editor**.

To simulate your model using the MyPID custom component:

1. Return to your MapleSim model.
2. Select the **MyMotor** custom component and click **Disable** () to exclude it from the next simulation.

- In the **Local Components** tab (🔍), the **MyPID** custom component is found in the **Components** palette. Place the **MyPID** custom component in the **Model Workspace**.
- In the **Library Components** tab (🔍), expand the **Signal Blocks** → **Common** menu and drag the **Feedback** component in the **Model Workspace**.
- Connect the components to your model, as shown below.

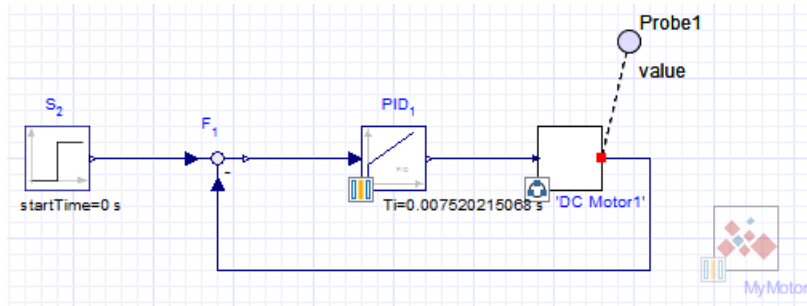

- Click **Run Simulation** (▶) in the **Main Toolbar** to simulate your model. When the simulation is complete, the following graph appears.

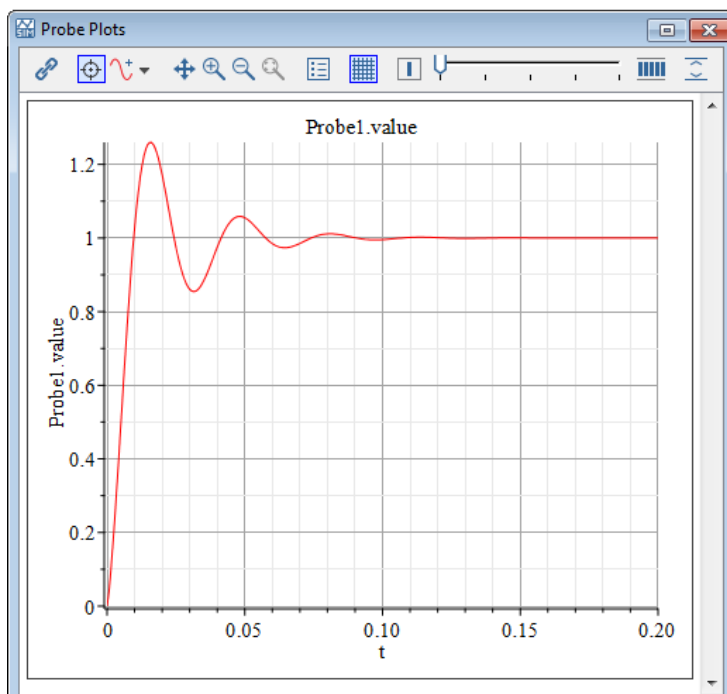

You can change the parameters of your controller directly in your model in MapleSim by selecting the PID controller component and editing the parameters in the **Properties** tab (📄).

Index

A

apps
Control Design, 1

B

Baumgarte, 2

C

Control Design Examples, 1
Control Design help, 1
Control Design package, iv
custom controller
creating, 2

E

Equilibrium Point, 2

G

generating a linearized model, 1

L

Linearization template, 1
linearized model
generating, 1

P

PID Tuning template, 2
Probe Plots, 3

S

Simulation Graph, 3

T

templates
Linearization, 1
PID Tuning, 2